

10

INDUSTRIAL BALL VALVES

- Bronze, cast iron and stainless steel ball valves with NPT and flanged connections.
- 22°F to 280°F fluid temperature rating ideal for chilled and hot water, and low and medium pressure steam.
- Fitted with damper type rotary actuators for easy field assembly and installation.
- RPTFE seats allows valve to operate in high temperature applications.
- Full ported for unobstructed flow.
- Wide range of sizes and C_v for various applications.

Applications

Available with spring return or non-spring return actuators, ball valves offer the solution for aggressive applications. The high close-off capabilities with high quality stainless steel trim allow these valves to be used in low and medium pressure steam applications and applications that operate with a higher media temperature.

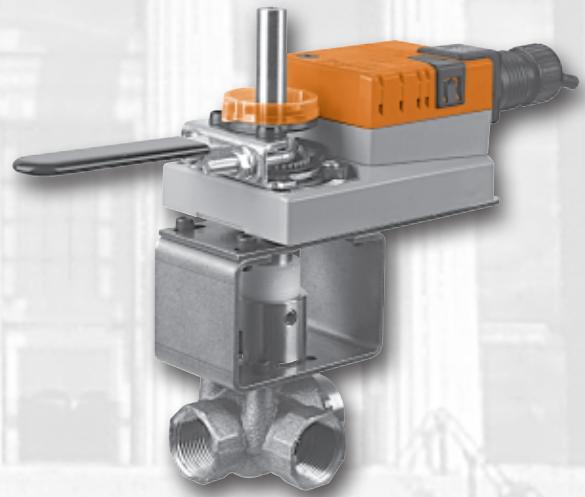

Ball Valve Nomenclature

B2	24	VS	AMX	24	-MFTX1	
Valve B2 = 2-way B3 = 3-way B6 = 2-way Flanged	Valve Size 12-80 = ½" to 3" 50-250 = 2" to 10" (Flanged)	Industrial Construction/Material VS = Bronze Body, Stainless Steel Ball and Stem VSS = Stainless Steel Body, Ball and Stem	Actuator Type Non-Spring Return LM... NM... AM... GM... SY... SY...P Spring Return LF... NF... AF... SY... SY...P	Power Supply 24 = 24 VAC/DC 120 = 120 VAC 230 = 230 VAC	Control -3X1 = On/Off, Floating Point -MFTX1 = Multi-Function Technology -MFT95 = 0-135 Ω	-S = Built-in Auxiliary Switch

Ordering Example

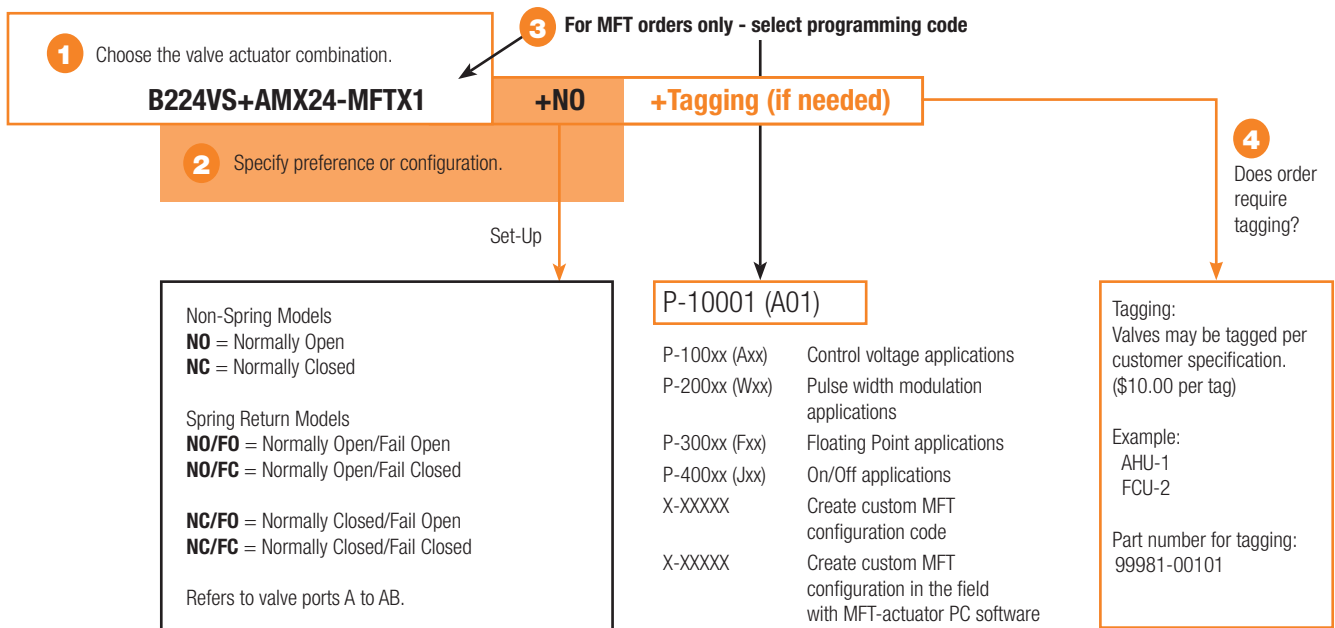

5 Complete Ordering Example: B224VS+AMX24-MFTX1+NO+A01

Control Valve Product Range

VS/VSS Ball Valve Product Range B2...VS/VSS, B3...VS, B6...VS

C _v	Valve Nominal Size		Type			Suitable Actuators			
	Inches	DN [mm]	2-way NPT	3-way NPT	2-Way Flanged	Spring Return	Non-Spring Return		
1	½	15	B212VS			LF Series	LM Series		
2	½	15	B213VS						
4	½	15	B214VS						
15	½	15	B215VS						
30	¾	20	B219VS			NF Series	NM Series		
51	¾	20	B220VS			AF Series	AM Series		
43	1	25	B224VS						
68	1	25	B225VS						
48	1¼	32	B232VS						
84	1½	40	B239VS						
177	1½	40	B240VS						
108	2	50	B249VS						
389	2	50	B250VS						
503	2½	65	B265VS						
370	3	80	B280VS						
15	½	15	B215VSS			LF Series	NM Series		
30	¾	20	B219VSS			AF Series	AM Series		
43	1	25	B224VSS						
48	1¼	32	B232VSS						
84	1½	40	B239VSS						
108	2	50	B249VSS						
503	2½	65	B265VSS						
370	3	80	B280VSS						
4.8	½	15		B315VS				LF	LM
11	¾	20		B320VS				NF	NM Series
21	1	25		B325VS				AF Series	AM Series
33	1¼	32		B332VS					
49	1½	40		B340VS					
91	2	50		B350VS					
330	2	50			B650VS	SY Series			
420	2½	65			B665VS				
600	3	80			B680VS				
1200	4	100			B6100VS				
3300	6	150			B6150VS				
9000	8	200			B6200VS				
12400	10	250			B6250VS				

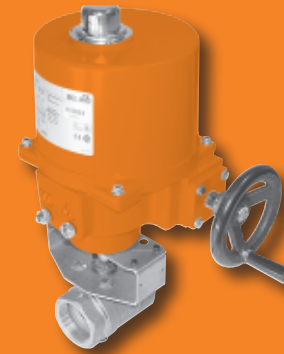

Applications

- Water-side control of air handling apparatus in ventilation and air-conditioning systems
- Water/Steam control in heating systems

Mode of Operation

The control valve is operated by an electronic actuator that responds to a standard voltage for on/off control, by a proportional VDC/4...20 mA, or 3-point control system. The actuator will then move the ball of the valve to the position dictated by the control signal thus change the flow.

Product Features

Modified equal percentage of flow for B2, B3 and B6. Modified linear flow for B3.

Actuator Specifications

Control type	On/Off, Floating Point, Proportional, 2-10 VDC Multi-Function Technology (MFT)
Manual override	LM, NM, GM, AM, SY, AF
Electrical connection	3 ft [1m] cable with ½" conduit fitting

Valve Specifications

Service	chilled or hot water, 60% glycol or steam
Flow characteristic	modified equal percentage (2-way), modified linear (3-way)
Sizes	½" to 10"
Type of end fitting	NPT (B2...VS & B3.. VS) flanged (B6...VS)
Materials	
Body	bronze (B2...VS & B3...VS), stainless steel (B2...VSS), cast iron (B6...VS)
Stem	stainless steel
Ball	stainless steel
Seats	MPTFE
Packing	RPTFE
Pressure rating	Up to 2000 psig WOG
Media temp range	
B2...VS, B3...VS	-22°F to 280°F [-30°C to 138°C]
B2...VSS	-22°F to 298°F [-30°C to 148°C]
Maximum inlet pressure	
Steam	35 psi B2...VS, B6...VS 50 psi B2...VSS

FLOW PATTERN

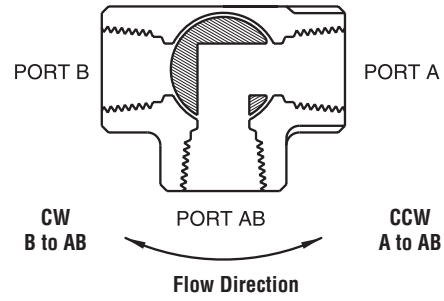
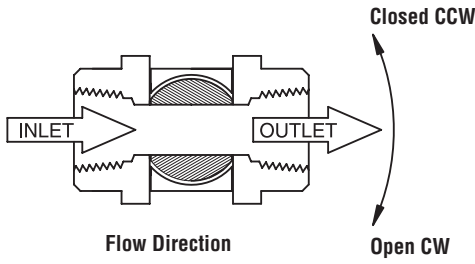

NOTE: B3...VS are piped differently than B3 CCV Valves.

VS SERIES BALL VALVE PIPING DIAGRAMS

2-way Valve Piping Diagram

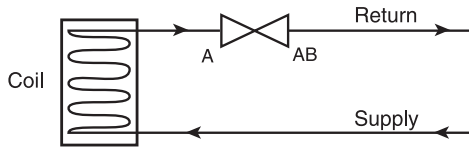

3-way Diverting Valve Piping Diagram

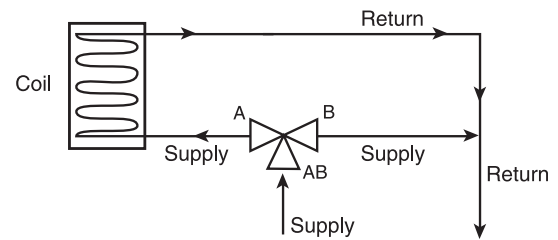

3-way Mixing Valve Piping Diagram

(N.C. TO COIL @ 0 VDC)

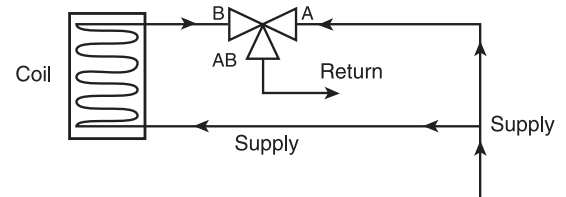

PIPING/MOUNTING ORIENTATION

Assembly can be mounted horizontally or vertically.
Do not install with actuator below pipe.

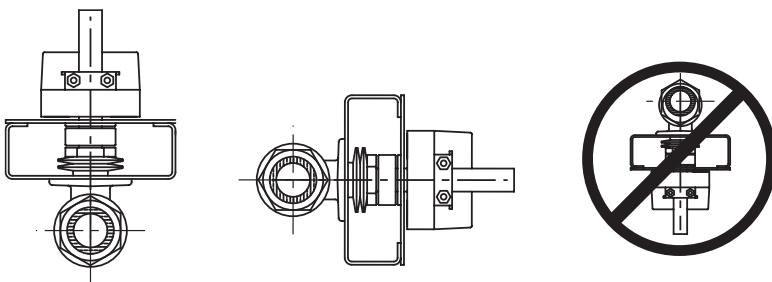

3-way Mixing Valve Piping Diagram

(N.O. TO COIL @ 0 VDC)

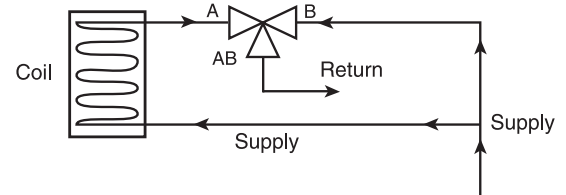

K20945 - 04/09 - Subject to change. © Belimo Aircontrols (USA), Inc.

VALVE SIZE	C _v	TYPE	MODEL #	LINE SIZE												
				¾" Fp Cv	1" Fp Cv	1¼" Fp Cv	1½" Fp Cv	2" Fp Cv	2½" Fp Cv	3" Fp Cv	4" Fp Cv	5" Fp Cv	6" Fp Cv	8" Fp Cv	10" Fp Cv	
½"	1	2W NPT	B212VS	1	1	—	—	—	—	—	—	—	—	—	—	—
½"	2	2W NPT	B213VS	2	2	—	—	—	—	—	—	—	—	—	—	—
½"	4	2W NPT	B214VS	4	4	—	—	—	—	—	—	—	—	—	—	—
½"	15	2W NPT	B215VS	9	8	—	—	—	—	—	—	—	—	—	—	—
¾"	30	2W NPT	B219VS	30	22	18	16	—	—	—	—	—	—	—	—	—
¾"	51	2W NPT	B220VS	51	27	20	18	—	—	—	—	—	—	—	—	—
1"	43	2W NPT	B224VS	—	43	37	31	26	—	—	—	—	—	—	—	—
1"	68	2W NPT	B225VS	—	68	49	37	30	—	—	—	—	—	—	—	—
1¼"	48	2W NPT	B232VS	—	—	48	45	38	35	—	—	—	—	—	—	—
1½"	84	2W NPT	B239VS	—	—	—	84	70	60	56	—	—	—	—	—	—
1½"	177	2W NPT	B240VS	—	—	—	177	103	78	68	—	—	—	—	—	—
2"	108	2W NPT	B249VS	—	—	—	—	108	101	92	84	—	—	—	—	—
2"	389	2W NPT	B250VS	—	—	—	—	389	222	160	125	—	—	—	—	—
2½"	503	2W NPT	B265VS	—	—	—	—	—	503	353	222	187	—	—	—	—
3"	370	2W NPT	B280VS	—	—	—	—	—	—	370	296	252	230	—	—	—
½"	5	3W NPT	B315VS	5	5	—	—	—	—	—	—	—	—	—	—	—
¾"	11	3W NPT	B320VS	11	11	—	—	—	—	—	—	—	—	—	—	—
1"	21	3W NPT	B325VS	—	21	21	19	18	—	—	—	—	—	—	—	—
1¼"	33	3W NPT	B332VS	—	—	33	32	29	28	—	—	—	—	—	—	—
1½"	49	3W NPT	B340VS	—	—	—	49	46	43	41	—	—	—	—	—	—
2"	91	3W NPT	B350VS	—	—	—	—	91	87	81	75	—	—	—	—	—
2"	330	2W FLG	B650VS	—	—	—	—	330	208	156	123	—	—	—	—	—
2½"	420	2W FLG	B665VS	—	—	—	—	—	420	320	215	185	—	—	—	—
3"	600	2W FLG	B680VS	—	—	—	—	—	—	600	384	300	264	—	—	—
4"	1200	2W FLG	B6100VS	—	—	—	—	—	—	—	1200	804	600	480	—	—
6"	3300	2W FLG	B6150VS	—	—	—	—	—	—	—	—	—	3300	1716	1254	—
8"	9000	2W FLG	B6200VS	—	—	—	—	—	—	—	—	—	—	9000	3870	—
10"	12400	2W FLG	B6250VS	—	—	—	—	—	—	—	—	—	—	—	—	12400

Fp Cv also apply to VSS where applicable.

B2...VS Series Ball Valve, Non-Spring Return Actuator

2-way Valve, Bronze Body, NPT Female Ends



Valve Specifications

Service	chilled or hot water, 60% glycol, 35# steam
Flow characteristic	modified equal percentage
Action	90° rotation
Sizes	½", ¾", 1", 1¼", 1½", 2", 2½", 3"
Type of end fitting	NPT female ends
Materials:	
Body	B584-C84400 bronze
Ball	316 stainless steel
Stem	316 stainless steel
Seats	MPTFE
Packing	RPTFE
Gland	B16 brass
Pressure rating	600 psig WOG
Media temp. range	-22°F to +280°F (-30°C to +138°C)
Maximum velocity	15 FPS



Non-Spring Return Actuators



ACTUATOR PART #	LMB24-3X1	NMB24-3X1	AMB24-3X1	GMB24-3X1	2*GMB24-3X1
Control type	On/Off, Floating Point	On/Off, Floating Point	On/Off, Floating Point	On/Off, Floating Point	On/Off, Floating Point
Manual override	•	•	•	•	•
Running time	95 seconds	90 seconds	95 seconds	135 seconds	135 seconds
Noise level	<35 dB(A)	<45 dB(A)	<45 dB(A)	<45 dB(A)	<45 dB(A)
ELECTRICAL CONNECTION:					
3 ft cable, ½" conduit fitting	•	•	•	•	•

Ball Valve Model #	Cv Rating	Valve Nominal Size		
		Inches	DN mm	Close-off psi

B2...VS 2-WAY BALL VALVE WITH NON-SPRING RETURN ACTUATORS

B212VS	1	½	15	50	\$506.00			
B213VS	2	½	15	50	\$506.00			
B214VS	4	½	15	50	\$506.00			
B215VS	15	½	15	50	\$506.00			
B219VS	30	¾	20	400		\$652.00		
B220VS	51	¾	20	400		\$674.00		
B224VS	43	1	25	400			\$748.00	
B225VS	68	1	25	200			\$838.00	
B232VS	48	1¼	32	400			\$986.00	
B239VS	84	1½	40	400				\$1,184.00
B240VS	177	1½	40	400‡				\$1,730.00
B249VS	108	2	50	200			\$1,382.00	
B250VS	389	2	50	200‡				\$2,364.00
B265VS	503	2½	65	100‡				\$3,866.00
B280VS	370	3	80	50‡				\$4,006.00

‡ 2" designates tandem.

K20945 - 04/09 - Subject to change. © Belimo Aircontrols (USA), Inc.

Valve Specifications

Service	chilled or hot water, 60% glycol, 35# steam
Flow characteristic	modified equal percentage
Action	90° rotation
Sizes	½", ¾", 1", 1¼", 1½", 2", 2½", 3"
Type of end fitting	NPT female ends
Materials:	
Body	B584-C84400 bronze
Ball	316 stainless steel
Stem	316 stainless steel
Seats	MPTFE
Packing	RPTFE
Gland	B16 brass
Pressure rating	600 psig WOG
Media temp. range	-22°F to +280°F (-30°C to +138°C)
Maximum velocity	15 FPS



Non-Spring Return Actuators



ACTUATOR PART #	LMX24-MFTX1	NMX24-MFTX1	AMX24-MFTX1	GMX24-MFTX1	2*GMX24-MFTX1
Control type	Proportional/MFT	Proportional/MFT	Proportional/MFT	Proportional/MFT	Proportional/MFT
Manual override	•	•	•	•	•
Running time	150 seconds (default) variable 35 to 150 seconds	150 seconds (default) variable 45 to 170 seconds	150 seconds (default) variable 90 to 350 seconds	150 seconds (default) variable 120 to 300 seconds	150 seconds (default)
Noise level	<35 dB(A)	<45 dB(A)	<45 dB(A)	<45 dB(A)	<45 dB(A)
ELECTRICAL CONNECTION:					
3 ft cable, ½" conduit fitting	•	•	•	•	•

Ball Valve Model #	C _v Rating	Valve Nominal Size			Close-off psi
		Inches	DN mm		
B212VS	1	½	15	50	\$690.00
B213VS	2	½	15	50	\$690.00
B214VS	4	½	15	50	\$690.00
B215VS	15	½	15	50	\$690.00
B219VS	30	¾	20	400	\$946.00
B220VS	51	¾	20	400	\$980.00
B224VS	43	1	25	400	\$1,014.00
B225VS	68	1	25	200	\$1,104.00
B232VS	48	1¼	32	400	\$1,220.00
B239VS	84	1½	40	400	
B240VS	177	1½	40	400	\$1,232.00
B249VS	108	2	50	200	\$1,500.00
B250VS	389	2	50	200	
B265VS	503	2½	65	100	\$2,514.00
B280VS	370	3	80	50	\$4,148.00 \$4,288.00

B2...VS 2-WAY BALL VALVE WITH NON-SPRING RETURN ACTUATORS

B212VS	1	½	15	50	\$690.00		
B213VS	2	½	15	50	\$690.00		
B214VS	4	½	15	50	\$690.00		
B215VS	15	½	15	50	\$690.00		
B219VS	30	¾	20	400	\$946.00		
B220VS	51	¾	20	400	\$980.00		
B224VS	43	1	25	400		\$1,014.00	
B225VS	68	1	25	200		\$1,104.00	
B232VS	48	1¼	32	400		\$1,220.00	
B239VS	84	1½	40	400			\$1,232.00
B240VS	177	1½	40	400			\$1,978.00
B249VS	108	2	50	200			\$1,500.00
B250VS	389	2	50	200			\$2,514.00
B265VS	503	2½	65	100			\$4,148.00
B280VS	370	3	80	50			\$4,288.00

MULTI-FUNCTION TECHNOLOGY

Description	P-CODE	Control Input	Running Time	Built-in Feedback	List Price
P-10001	A01	2-10 VDC	150 seconds	2-10 VDC	No Charge
P-10002	A02	0-10 VDC	150 seconds	0-10 VDC	No Charge
P-10028	A28	0-10 VDC	100 seconds	0-10 VDC	No Charge
P-10063	A63	0.5-4.5 VDC	150 seconds	0.5-4.5 VDC	No Charge
P-10064	A64	5.5-10 VDC	150 seconds	5.5-10 VDC	No Charge
P-20002	W02	0.02-5.00 seconds PWM	150 seconds	2-10 VDC	No Charge
P-20003	W03	0.10-25.5 seconds PWM	150 seconds	2-10 VDC	No Charge
P-30001	F01	Floating Point	150 seconds	2-10 VDC	No Charge
P-40002	J02	On/Off	150 seconds	2-10 VDC	No Charge

Add the P... pre-set MFT configuration number and list price to the actuator when ordering, as needed.

Note: Most popular configurations available at no additional cost. All other configurations carry a \$34.00 list price.

Dual mounted actuators use standard run time only (no reprogramming of standard run time allowed).

K20945 - 04/09 - Subject to change. © Belimo Aircontrols (USA), Inc.

B2...VS Series Ball Valve, Spring Return Actuator

2-way Valve, Bronze Body, NPT Female Ends



Valve Specifications

Service	chilled or hot water, 60% glycol, 35# steam
Flow characteristic	modified equal percentage
Action	90° rotation
Sizes	½", ¾", 1", 1¼", 1½", 2"
Type of end fitting	NPT female ends
Materials:	
Body	B584-C84400 bronze
Ball	316 stainless steel
Stem	316 stainless steel
Seats	MPTFE
Packing	RPTFE
Gland	B16 brass
Pressure rating	600 psi WOG
Media temp. range	-22°F to +280°F [-30°C to +138°C]
Maximum velocity	15 FPS



Spring Return Actuators

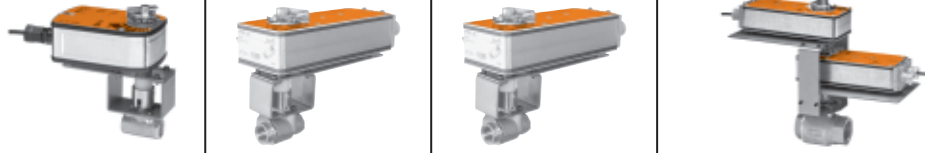

ACTUATOR PART #	LF24 US	LF24-MFT US	NF24 US	NF24-MFT US	AF24 US	AF24-MFT US	2*AF24 US	2*AF120 US	2*AF24-MFT US
Control type	On/Off	Proportional/MFT	On/Off	Proportional/MFT	On/Off	Proportional/MFT	On/Off	On/Off	Proportional/MFT
Manual override					•	•	•	•	•
Running time	motor: <40 to 75 seconds spring: <25 seconds	motor: 150 seconds spring: <25 seconds	motor: <75 seconds spring: <60 seconds	motor: 150 seconds spring: <60 seconds	motor: 150 seconds spring: <20 seconds	motor: 150 seconds spring: <20 seconds	motor: 150 seconds spring: <20 seconds	motor: 150 seconds spring: <20 seconds	motor: 150 seconds spring: <20 seconds
Noise level	<50 dB(A) spring: <62 dB(A)	<30 dB(A) spring: <62 dB(A)	<45 dB(A)	<45 dB(A)	<45 dB(A)	<45 dB(A)	<45 dB(A)	<45 dB(A)	<45 dB(A)

ELECTRICAL CONNECTION:

3 ft cable, ½" conduit fitting	•	•	•	•	•	•	•	•	•
--------------------------------	---	---	---	---	---	---	---	---	---

Valve Nominal Size

Ball Valve Model #	Cv Rating	Inches	DN mm	Close-off psi
--------------------	-----------	--------	-------	---------------

B2...VS 2-WAY BALL VALVE WITH SPRING RETURN ACTUATORS

B212VS	1	½	15	50	\$548.00	\$764.00						
B213VS	2	½	15	50	\$548.00	\$764.00						
B214VS	4	½	15	50	\$548.00	\$764.00						
B215VS	15	½	15	50	\$548.00	\$764.00						
B219VS	30	¾	20	400			\$744.00	\$956.00				
B220VS	51	¾	20	200			\$778.00	\$992.00				
B224VS	43	1	25	400					\$840.00	\$1,046.00		
B225VS	68	1	25	50					\$1,002.00	\$1,154.00		
B232VS	48	1¼	32	200					\$1,060.00	\$1,222.00		
B239VS	84	1½	40	400							\$1,588.00	\$1,696.00
B240VS	177	1½	40	50							\$1,628.00	\$1,738.00
B249VS	108	2	50	200							\$1,796.00	\$1,904.00

MULTI-FUNCTION TECHNOLOGY

Description	P-CODE	Control Input	Running Time	Built-in Feedback	List Price
P-10001	A01	2-10 VDC	150 seconds	2-10 VDC	No Charge
P-10002	A02	0-10 VDC	150 seconds	0-10 VDC	No Charge
P-10028	A28	0-10 VDC	100 seconds	0-10 VDC	No Charge
P-10063	A63	0.5-4.5 VDC	150 seconds	0.5-4.5 VDC	No Charge
P-10064	A64	5.5-10 VDC	150 seconds	5.5-10 VDC	No Charge
P-20002	W02	0.02-5.00 seconds PWM	150 seconds	2-10 VDC	No Charge
P-20003	W03	0.10-25.5 seconds PWM	150 seconds	2-10 VDC	No Charge
P-30001	F01	Floating Point	150 seconds	2-10 VDC	No Charge
P-40002	J02	On/Off	150 seconds	2-10 VDC	No Charge

Add the P... pre-set MFT configuration number and list price to the actuator when ordering, as needed.

Note: Most popular configurations available at no additional cost.

800-543-9038 USA

866-805-7089 CANADA

203-791-8396 LATIN AMERICA

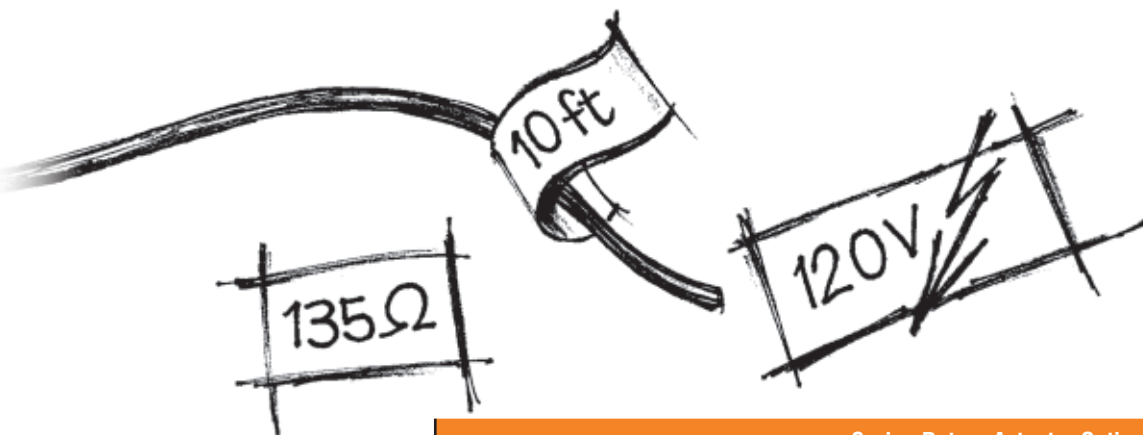

Spring Return Actuator Options

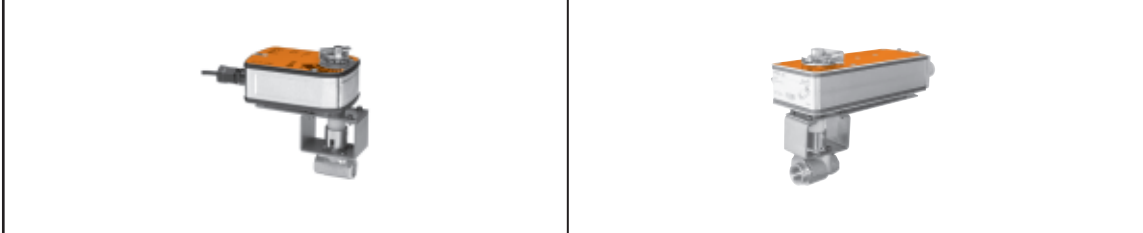

OPTIONS	LF24-S US	LF120 US	LF120-S US	NF24-S US	NF120 US	NF120-S US
Control type	On/Off	On/Off	On/Off	On/Off	On/Off	On/Off
Built-in auxiliary switch (-S)	•	•	•	•	•	•
120 VAC power supply					•	•
Ball Valve Model #	C_v Rating					
B2...VS 2-WAY BALL VALVE WITH SPRING RETURN ACTUATORS						
B212VS	1	\$602.00	\$582.00	\$638.00		
B213VS	2	\$602.00	\$582.00	\$638.00		
B214VS	4	\$602.00	\$582.00	\$638.00		
B215VS	15	\$602.00	\$582.00	\$638.00		
B219VS	30				\$824.00	\$788.00
B220VS	51				\$860.00	\$818.00

Spring Return Actuator Options



OPTIONS	AF24-S US	AF120 US	AF120-S US	AF24-MFT-S US	AF24-MFT95 US	2*AF24-S US	2*AF120-S US	2*AF24-MFT-S US	2*AF24-MFT95 US
Control type	On/Off	On/Off	On/Off	Proportional/MFT	0-135 Ω	On/Off	On/Off	Proportional/MFT	0-135 Ω
Built-in auxiliary switch (-S)	•	•	•	•		•	•	•	
120 VAC power supply		•	•				•		
Ball Valve Model #	C_v Rating								
B2...VS 2-WAY BALL VALVE WITH SPRING RETURN ACTUATORS									
B224VS	43	\$926.00	\$896.00	\$982.00	\$1,132.00	\$1,068.00			
B225VS	68	\$1,088.00	\$1,058.00	\$1,142.00	\$1,220.00	\$1,174.00			
B232VS	48	\$1,144.00	\$1,114.00	\$1,200.00	\$1,288.00	\$1,242.00			
B239VS	84						\$1,674.00	\$1,782.00	\$1,962.00
B240VS	177						\$1,716.00	\$1,826.00	\$2,024.00
B249VS	108						\$1,882.00	\$1,990.00	\$2,184.00

* For tandem actuators – only one of the two actuators is provided with switch. For MFT95 models only one will be MFT95. Note: Specify configuration.

K20945 - 04/09 - Subject to change. © Belimo Aircontrols (USA), Inc.

B3...VS Series Ball Valve, Non-Spring Return Actuator

3-way Valve, Bronze Body, NPT Female Ends



Valve Specifications

Service	chilled or hot water, 60% glycol
Flow characteristic	modified equal percentage
Action	90° rotation (A to AB open CCW, B to AB open CW)
Sizes	½", ¾", 1", 1¼", 1½", 2"
Type of end fitting	NPT female ends
Materials:	
Body	B584-C84400 bronze
Ball	316 stainless steel
Stem	316 stainless steel
Seats	MPTFE
Packing	RPTFE
Gland	B16 brass
Pressure rating	400 psig WOG
Media temp. range	-22°F to +280°F [-30°C to +138°C]
Maximum velocity	15 FPS



Non-Spring Return Actuators



ACTUATOR PART #	LMB24-3X1	LNX24-MFTX1	NMB24-3X1	NMX24-MFTX1	AMB24-3X1	AMX24-MFTX1	GMB24-3X1	GMX24-MFTX1
Control type	On/Off, Floating Point	Proportional/ MFT	On/Off, Floating Point	Proportional/ MFT	On/Off, Floating Point	Proportional/ MFT	On/Off, Floating Point	Proportional/ MFT
Manual override	•	•	•	•	•	•	•	•
Running time	90 seconds	150 seconds (default) variable 35 to 150 seconds	95 seconds	150 seconds (default) variable 45 to 170 seconds	95 seconds	150 seconds (default) variable 90 to 350 seconds	135 seconds	150 seconds (default) variable 120 to 300 seconds
Noise level	<35 dB(A)	<35 dB(A)	<45 dB(A)	<45 dB(A)	<45 dB(A)	<45 dB(A)	<45 dB(A)	<45 dB(A)
ELECTRICAL CONNECTION:								
3 ft cable, ½" conduit fitting	•	•	•	•	•	•	•	•
Valve Nominal Size								
Ball Valve Model #	C_v Rating	Inches	DN mm	Close-off psi				

B3...VS 3-WAY BALL VALVE WITH NON-SPRING RETURN ACTUATORS

Ball Valve Model #	C _v Rating	Inches	DN mm	Close-off psi	LMB24-3X1	LNX24-MFTX1	NMB24-3X1	NMX24-MFTX1	AMB24-3X1	AMX24-MFTX1	GMB24-3X1	GMX24-MFTX1
B315VS	4.8	½	15	75	\$576.00	\$798.00						
B320VS	11	¾	20	75			\$724.00	\$922.00				
B325VS	21	1	25	75			\$904.00	\$1,052.00				
B332VS	33	1¼	32	75					\$1,138.00	\$1,272.00		
B340VS	49	1½	40	75							\$1,588.00	\$1,620.00
B350VS	91	2	50	75							\$2,056.00	\$2,296.00

MULTI-FUNCTION TECHNOLOGY

Description	P-CODE	Control Input	Running Time	Built-in Feedback	List Price
P-10001	A01	2-10 VDC	150 seconds	2-10 VDC	No Charge
P-10002	A02	0-10 VDC	150 seconds	0-10 VDC	No Charge
P-10028	A28	0-10 VDC	100 seconds	0-10 VDC	No Charge
P-10063	A63	0.5-4.5 VDC	150 seconds	0.5-4.5 VDC	No Charge
P-10064	A64	5.5-10 VDC	150 seconds	5.5-10 VDC	No Charge
P-20002	W02	0.02-5.00 seconds PWM	150 seconds	2-10 VDC	No Charge
P-20003	W03	0.10-25.5 seconds PWM	150 seconds	2-10 VDC	No Charge
P-30001	F01	Floating Point	150 seconds	2-10 VDC	No Charge
P-40002	J02	On/Off	150 seconds	2-10 VDC	No Charge

Add the P... pre-set MFT configuration number and list price to the actuator when ordering, as needed.

Note: Most popular configurations available at no additional cost. All other configurations carry a \$34.00 list price.

K20945 - 04/09 - Subject to change. © Belimo Aircontrols (USA), Inc.

Valve Specifications

Service	chilled or hot water, 60% glycol
Flow characteristic	modified equal percentage
Action	90° rotation (A to AB open CCW, B to AB open CW)
Sizes	½", ¾", 1", 1¼", 1½", 2"
Type of end fitting	NPT female ends
Materials:	
Body	B584-C84400 bronze
Ball	316 stainless steel
Stem	316 stainless steel
Seats	MPTFE
Packing	RPTFE
Gland	B16 brass
Pressure rating	400 psig WOG
Media temp. range	-22°F to +280°F [-30°C to +138°C]
Maximum velocity	15 FPS



Non-Spring Return Actuators

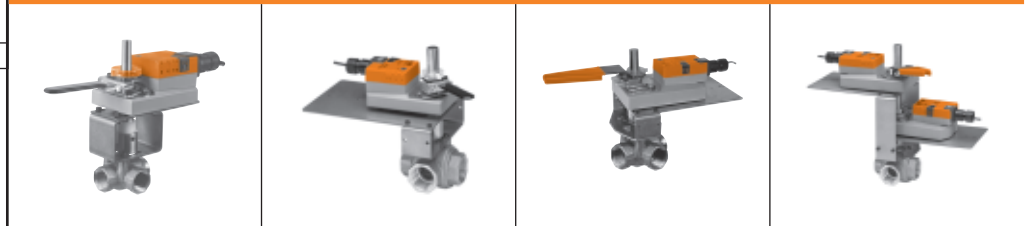

ACTUATOR PART #	NMB24-3X1	NMX24-MFTX1	AMB24-3X1	AMX24-MFTX1	GMB24-3X1	GMX24-MFTX1	2*GMB24-3X1	2*GMX24-MFTX1
Control type	On/Off, Floating Point	Proportional/ MFT	On/Off, Floating Point	Proportional/ MFT	On/Off, Floating Point	Proportional/ MFT	On/Off, Floating Point	Proportional/ MFT
Manual override	•	•	•	•	•	•	•	•
Running time	90 seconds	150 seconds (default) variable 45 to 170 seconds	95 seconds	150 seconds (default) variable 90 to 350 seconds	135 seconds	150 seconds (default) variable 120 to 300 seconds	135 seconds	150 seconds (default)
Noise level	<45 dB(A)	<45 dB(A)	<45 dB(A)	<45 dB(A)	<45 dB(A)	<45 dB(A)	<45 dB(A)	<45 dB(A)
ELECTRICAL CONNECTION:								
3 ft cable, ½" conduit fitting	•	•	•	•	•	•	•	•
Valve Nominal Size								
Ball Valve Model #	C_v Rating	Inches	DN mm	Close-off psi				

B3...VS 3-WAY BALL VALVE WITH NON-SPRING RETURN ACTUATORS									
B315VS	4.8	½	15	200	\$608.00	\$912.00			
B320VS	11	¾	20	200		\$758.00	\$1,008.00		
B325VS	21	1	25	200		\$942.00	\$1,136.00		
B332VS	33	1¼	32	200			\$1,314.00	\$1,400.00	
B340VS	49	1½	40	200				\$2,128.00	\$2,186.00
B350VS	91	2	50	200				\$2,556.00	\$2,910.00

Dual mounted actuators use standard run time only (no reprogramming of standard run time allowed).

K20945 - 04/09 - Subject to change. © Belimo Aircontrols (USA), Inc.

B3...VS Series Ball Valve, Spring Return Actuator

3-way Valve, Bronze Body, NPT Female Ends



Valve Specifications

Service	chilled or hot water, 60% glycol
Flow characteristic	modified equal percentage
Action	90° rotation (A to AB open CCW, B to AB open CW)
Sizes	½", ¾", 1", 1¼", 1½", 2"
Type of end fitting	NPT female ends
Materials:	
Body	B584-C84400 bronze
Ball	316 stainless steel
Stem	316 stainless steel
Seats	MPTFE
Packing	RPTFE
Gland	B16 brass
Pressure rating	400 psig WOG
Media temp. range	-22°F to +280°F [-30°C to +138°C]
Maximum velocity	15 FPS



Spring Return Actuator



ACTUATOR PART #	LF24 US	LF24-MFT US	NF24 US	NF24-MFT US	AF24 US	AF24-MFT US	AF24-MFT95 US	2*AF24 US	2*AF24-MFT US	2*AF24-MFT95 US
Control type	On/Off	Proportional/MFT	On/Off	Proportional/MFT	On/Off	Proportional/MFT	Proportional/MFT95	On/Off	Proportional/MFT	Proportional/MFT95
Manual override					•	•	•	•	•	•
Running time	motor: <40 to 75 seconds spring: <25 seconds	motor: 150 seconds spring: <25 seconds	motor: 75 seconds spring: <60 seconds	motor: 150 seconds spring: <60 seconds	motor: 150 seconds spring: <20 seconds	motor: 150 seconds spring: <20 seconds	motor: 150 seconds spring: <20 seconds	motor: 150 seconds spring: <20 seconds	motor: 150 seconds spring: <20 seconds	motor: 150 seconds spring: <20 seconds
Noise level	<50 dB(A)	<50 dB(A)	<45 dB(A)	<45 dB(A)	<45 dB(A)	<45 dB(A)	<45 dB(A)	<45 dB(A)	<45 dB(A)	<45 dB(A)
ELECTRICAL CONNECTION:										
3 ft cable, ½" conduit fitting	•	•	•	•	•	•	•	•	•	•
Valve Nominal Size										
Ball Valve Model #	C _v Rating	Inches	DN mm	Close-off psi						

B3...VS 3-WAY BALL VALVE WITH SPRING RETURN ACTUATORS

B315VS	4.8	½	15	75	\$636.00	\$870.00						
B320VS	11	¾	20	75		\$768.00	\$1,010.00					
B325VS	21	1	25	75				\$1,028.00	\$1,218.00	\$1,240.00		
B332VS	33	1¼	32	75				\$1,204.00	\$1,292.00	\$1,314.00		
B340VS	49	1½	40	75							\$1,936.00	\$2,090.00
B350VS	91	2	50	75							\$2,668.00	\$2,794.00

MULTI-FUNCTION TECHNOLOGY

Description	P-CODE	Control Input	Running Time	Built-in Feedback	List Price
P-10001	A01	2-10 VDC	150 seconds	2-10 VDC	No Charge
P-10002	A02	0-10 VDC	150 seconds	0-10 VDC	No Charge
P-10028	A28	0-10 VDC	100 seconds	0-10 VDC	No Charge
P-10063	A63	0.5-4.5 VDC	150 seconds	0.5-4.5 VDC	No Charge
P-10064	A64	5.5-10 VDC	150 seconds	5.5-10 VDC	No Charge
P-20002	W02	0.02-5.00 seconds PWM	150 seconds	2-10 VDC	No Charge
P-20003	W03	0.10-25.5 seconds PWM	150 seconds	2-10 VDC	No Charge
P-30001	F01	Floating Point	150 seconds	2-10 VDC	No Charge
P-40002	J02	On/Off	150 seconds	2-10 VDC	No Charge

Add the P... pre-set MFT configuration number and list price to the actuator when ordering, as needed.

Note: Most popular configurations available at no additional cost.

* For tandem actuators – only one of the two actuators is provided with switch.

K20945 - 04/09 - Subject to change. © Belimo Aircontrols (USA), Inc.

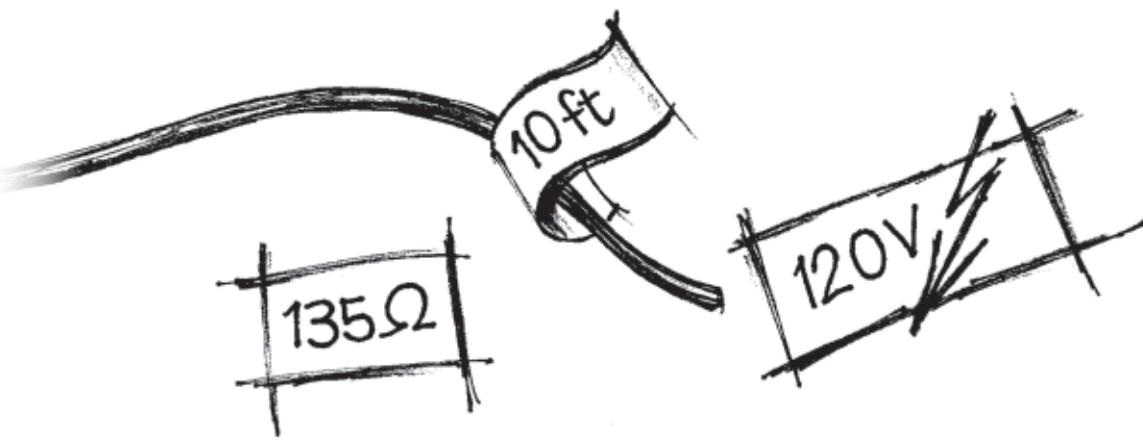

Spring Return Actuator Options

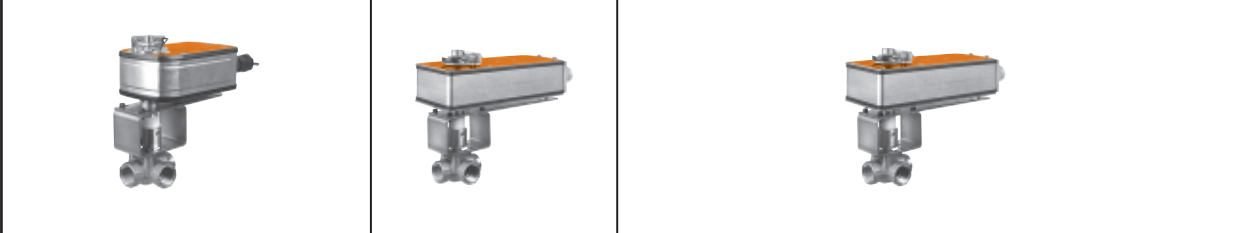

OPTIONS	LF24-S US	LF120 US	LF120-S US	NF24-S US	NF120-S US	AF24-S US	AF120 US	AF120-S US	AF24-MFT-S US	AF24-MFT95 US
Control type	On/Off	On/Off	On/Off	On/Off	On/Off	On/Off	On/Off	On/Off	Proportional/MFT	0-135 Ω
Built-in auxiliary switch	•	•	•	•	•	•	•	•	•	
120 VAC power supply		•	•		•		•	•		
Ball Valve Model #	C_v Rating									

B3...VS 3-WAY BALL VALVE WITH SPRING RETURN ACTUATORS										
B315VS	4.8	\$668.00	\$668.00	\$722.00						
B320VS	11				\$908.00	\$948.00				
B325VS	21						\$1,118.00	\$1,084.00	\$1,174.00	\$1,304.00
B332VS	33						\$1,292.00	\$1,258.00	\$1,346.00	\$1,382.00

* For tandem actuators – only one of the two actuators is provided with switch. For MFT95 models only one will be MFT95. Note: Specify configuration.

Spring Return Actuator Options



OPTIONS	2*AF24-S US	2*AF120 US	2*AF120-S US	2*AF24-MFT-S US	2*AF24-MFT95 US
Control type	On/Off	On/Off	On/Off	Proportional/MFT	0-135 Ω
Built-in auxiliary switch	•			•	
120 VAC power supply		•	•		
Ball Valve Model #	C_v Rating				

B3...VS 2-WAY BALL VALVE WITH SPRING RETURN ACTUATORS						
B340VS	49	\$2,024.00	\$2,044.00	\$2,134.00	\$2,176.00	\$2,040.00
B350VS	91	\$2,758.00	\$2,778.00	\$2,866.00	\$2,880.00	\$2,720.00

* For tandem actuators – only one of the two actuators is provided with switch. For MFT95 models only one will be MFT95. Note: Specify configuration.

K20945 - 04/09 - Subject to change. © Belimo Aircontrols (USA), Inc.

B3...VS Series Ball Valve, Spring Return Actuator

3-way Valve, Bronze Body, NPT Female Ends



Valve Specifications

Service	chilled or hot water, 60% glycol
Flow characteristic	modified equal percentage
Action	90° rotation (A to AB open CCW, B to AB open CW)
Sizes	½", ¾", 1", 1¼"
Type of end fitting	NPT female ends
Materials:	
Body	B584-C84400 bronze
Ball	316 stainless steel
Stem	316 stainless steel
Seats	MPTFE
Packing	RPTFE
Gland	B16 brass
Pressure rating	400 psig WOG
Media temp. range	-22°F to +280°F [-30°C to +138°C]
Maximum velocity	15 FPS



Spring Return Actuator



ACTUATOR PART #	NF24 US	NF24-MFT US	AF24 US	AF24-MFT US	AF24-MFT95	2*AF24 US	2*AF24-MFT US	2*AF24-MFT95 US
Control type	On/Off	Proportional/ MFT	On/Off	Proportional/ MFT	Proportional/ MFT95	On/Off	Proportional/ MFT	Proportional/ MFT
Manual override			•	•	•	•	•	•
Running time	motor: 75 seconds spring: <60 seconds	motor: 150 seconds spring: <60 seconds	motor: 150 seconds spring: <20 seconds	motor: 150 seconds spring: <20 seconds	motor: 150 seconds spring: <20 seconds	motor: 150 seconds spring: <20 seconds	motor: 150 seconds spring: <20 seconds	motor: 150 seconds spring: <20 seconds
Noise level	<45 dB(A)	<45 dB(A)	<45 dB(A)	<45 dB(A)	<45 dB(A)	<45 dB(A)	<45 dB(A)	<45 dB(A)
ELECTRICAL CONNECTION:								
3 ft cable, ½" conduit fitting	•	•	•	•	•	•	•	•
Valve Nominal Size								
Ball Valve Model #	Cv Rating	Inches	DN mm	Close-off psi				

B3...VS 3-WAY BALL VALVE WITH SPRING RETURN ACTUATORS

B315VS	4.8	½	15	200	\$674.00	\$940.00				
B320VS	11	¾	20	200		\$824.00	\$1,072.00	\$1,092.00		
B325VS	21	1	25	200				\$1,490.00	\$1,668.00	\$2,088.00
B332VS	33	1¼	32	200				\$1,664.00	\$1,910.00	\$1,932.00

Note: Specify configuration.

MULTI-FUNCTION TECHNOLOGY

Description	P-CODE	Control Input	Running Time	Built-in Feedback	List Price
P-10001	A01	2-10 VDC	150 seconds	2-10 VDC	No Charge
P-10002	A02	0-10 VDC	150 seconds	0-10 VDC	No Charge
P-10028	A28	0-10 VDC	100 seconds	0-10 VDC	No Charge
P-10063	A63	0.5-4.5 VDC	150 seconds	0.5-4.5 VDC	No Charge
P-10064	A64	5.5-10 VDC	150 seconds	5.5-10 VDC	No Charge
P-20002	W02	0.02-5.00 seconds PWM	150 seconds	2-10 VDC	No Charge
P-20003	W03	0.10-25.5 seconds PWM	150 seconds	2-10 VDC	No Charge
P-30001	F01	Floating Point	150 seconds	2-10 VDC	No Charge
P-40002	J02	On/Off	150 seconds	2-10 VDC	No Charge

Add the P... pre-set MFT configuration number and list price to the actuator when ordering, as needed.

Note: Most popular configurations available at no additional cost.

* For tandem actuators – only one of the two actuators is provided with switch.

K20945 - 04/09 - Subject to change. © Belimo Aircontrols (USA), Inc.

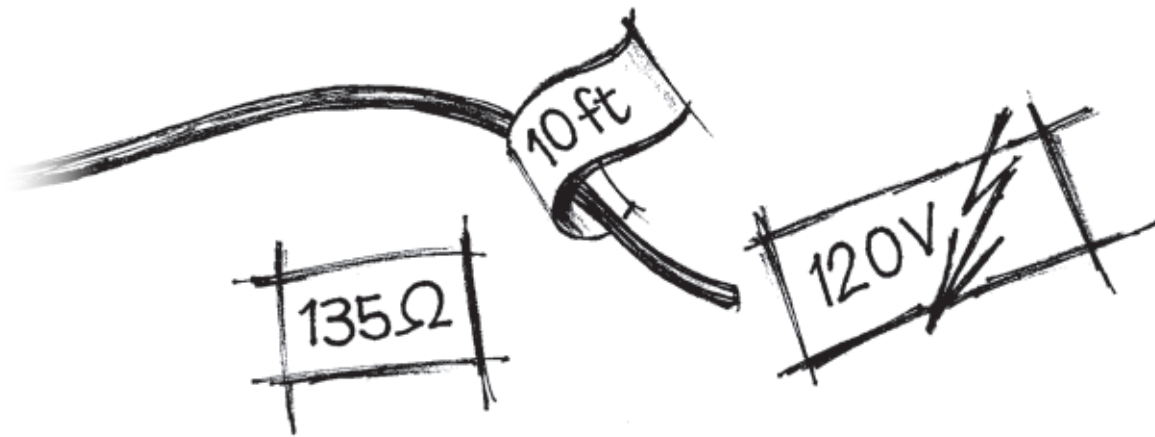

Spring Return Actuator Options



OPTIONS	NF24-S US	NF120 US	NF120-S US
Control type	On/Off	On/Off	On/Off
Built-in auxiliary switch (-S)	•	•	•
120 VAC power supply		•	•
Ball Valve Model #	C_v Rating		
B3...VS 3-WAY BALL VALVE WITH SPRING RETURN ACTUATORS			
B315VS	4.8	\$758.00	\$718.00
			\$799.00

Spring Return Actuator Options



OPTIONS	AF24-S US	AF120 US	AF120-S US	AF24-MFT-S US	AF24-MFT95 US	2*AF24-S US	2*AF120 US	2*AF120-S US	2*AF24-MFT-S US	2*AF24-MFT95 US
Control type	On/Off	On/Off	On/Off	Proportional/MFT	0-135 Ω	On/Off	On/Off	On/Off	Proportional/MFT	0-135 Ω
Built-in auxiliary switch (-S)	•	•	•	•	•	•	•	•	•	•
120 VAC power supply		•	•							
Ball Valve Model #	C_v Rating									
B3...VS 3-WAY BALL VALVE WITH SPRING RETURN ACTUATORS										
B320VS	11	\$912.00	\$880.00	\$968.00	\$1,160.00	\$1,092.00				
B325VS	21					\$1,574.00	\$1,600.00	\$1,686.00	\$1,755.00	\$2,087.00
B332VS	33					\$1,750.00	\$1,772.00	\$1,860.00	\$1,996.00	\$1,930.00
B340VS	49					\$2,023.00	\$2,044.00	\$2,132.00	\$2,175.00	\$2,039.00
B350VS	91					\$2,756.00	\$2,777.00	\$2,865.00	\$2,880.00	\$2,719.00

* For tandem actuators – only one of the two actuators is provided with switch. For MFT95 models only one will be MFT95. Note: Specify configuration.

K20945 - 04/09 - Subject to change. © Belimo Aircontrols (USA), Inc.

B2...VS Series Ball Valve, Non-Spring Return Actuator

2-way Valve, Bronze Body, NPT Female Ends with NEMA 4X Industrial Style Actuator



Valve Specifications

Service	chilled or hot water, 60% glycol, 35# steam
Flow characteristic	modified equal percentage
Action	90° rotation
Sizes	½", ¾", 1", 1¼", 1½", 2", 2½", 3"
Type of end fitting	NPT female ends
Materials:	
Body	B584-C84400 bronze
Ball	316 stainless steel
Stem	316 stainless steel
Seats	MPTFE
Packing	RPTFE
Gland	B16 brass
Pressure Rating	600 psig WOG
Media temp. range	-22°F to +280°F [-30°C to +138°C]
Maximum velocity	15 FPS



Non-Spring Return Actuators



ACTUATOR PART #	SY1-24, SY1-110, SY1-220	SY1-24P, SY1-110P, SY1-220P	SY2-24, SY2-110, SY2-220	SY2-24MFT SY2-120MFT SY2-230MFT	SY3-24, SY3-110, SY3-220	SY3-24MFT SY3-120MFT SY3-230MFT
Control type	On/Off, Floating Point	Proportional	On/Off, Floating Point	Proportional/MFT	On/Off, Floating Point	Proportional/MFT
Manual override	•	•	•	•	•	•
Running time	SY#-24, SY#-24P/MFT	12 seconds	12 seconds	15 seconds	15 seconds	22 seconds
	SY#-110, SY#-110P/MFT SY#-220, SY#-220P/MFT	12 seconds	12 seconds	15 seconds	15 seconds	22 seconds
ELECTRICAL CONNECTION:						
2 (two), ½" conduit fittings / covered terminal strip	•	•	•	•	•	•
Valve Nominal Size						
Ball Valve Model #	C_v Rating	Inches	DN mm	Close-off psi		

B2...VS 2-WAY BALL VALVE WITH NON-SPRING RETURN ACTUATORS										
B212VS	1	½	15	600	\$1,204.00	\$3,128.00	\$2,422.00	\$4,500.00		
B213VS	2	½	15	600	\$1,204.00	\$3,128.00	\$2,422.00	\$4,500.00		
B214VS	4	½	15	600	\$1,204.00	\$3,128.00	\$2,422.00	\$4,500.00		
B215VS	15	½	15	600	\$1,204.00	\$3,128.00	\$2,422.00	\$4,500.00		
B219VS	30	¾	20	600	\$1,334.00	\$3,240.00	\$2,518.00	\$4,600.00		
B220VS	51	¾	20	600	\$1,352.00	\$3,258.00	\$2,538.00	\$4,620.00		
B224VS	43	1	25	600	\$1,376.00	\$3,278.00	\$2,558.00	\$4,640.00		
B225VS	68	1	25	600	\$1,390.00	\$3,294.00	\$2,660.00	\$4,744.00		
B232VS	48	1¼	32	600	\$1,510.00	\$3,416.00	\$2,780.00	\$4,866.00		
B239VS	84	1½	40	600	\$1,564.00	\$3,474.00	\$2,838.00	\$4,922.00		
B240VS	177	1½	40	600			\$2,902.00	\$4,986.00		
B249VS	108	2	50	600			\$3,070.00	\$5,150.00		
B250VS	389	2	50	600			\$3,390.00	\$5,444.00		
B265VS	503	2½	65	600			\$5,122.00	\$7,204.00		
B280VS	370	3	80	600					\$5,266.00	\$7,346.00

Note: Specify configuration.

K20945 - 04/09 - Subject to change. © Belimo Aircontrols (USA), Inc.

Valve Specifications

Service	chilled or hot water, 60% glycol, 50# steam
Flow characteristic	modified equal percentage
Action	90° rotation
Sizes	½", ¾", 1", 1¼", 1½", 2", 2½"
Type of end fitting	NPT female ends
Materials:	
Body	A351-CF8M stainless steel
Ball	316 stainless steel
Stem	316 stainless steel
Seats	MPTFE
Packing	RPTFE
Gland	B16 brass
Pressure rating	2000 psig WOG (½" to 1") 1500 psig WOG (1¼"-2") 1000 psig WOG (2½")
Media temp. range	-22°F to +298°F [-30°C to +148°C]
Maximum velocity	15 FPS



Non-Spring Return Actuators

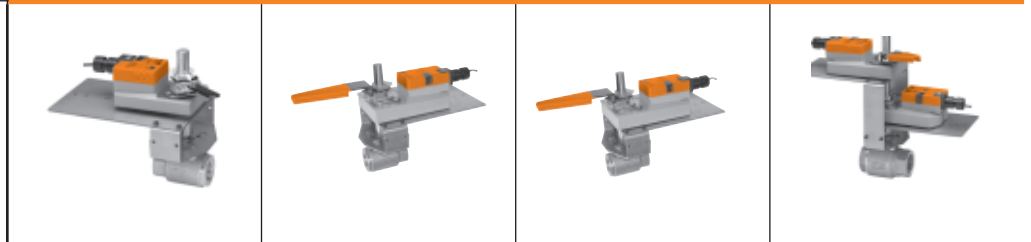

ACTUATOR PART #	NMB24-3X1	NMX24-MFTX1	AMB24-3X1	AMX24-MFTX1	GMB24-3X1	GMX24-MFTX1	2*GMB24-3X1	2*GMX24-MFTX1
Control type	On/Off, Floating Point	Proportional/ MFT	On/Off, Floating Point	Proportional/ MFT	On/Off, Floating Point	Proportional/ MFT	On/Off, Floating Point	Proportional/ MFT
Manual override	•	•	•	•	•	•	•	•
Running time	90 seconds	150 seconds (default) variable 45 to 170 seconds	90 seconds	150 seconds (default) variable 90 to 350 seconds	135 seconds	150 seconds (default) variable 120 to 300 seconds	135 seconds	150 seconds (default)
Noise level	<45 dB(A)	<45 dB(A)	<45 dB(A)	<45 dB(A)	<45 dB(A)	<45 dB(A)	<45 dB(A)	<45 dB(A)

ELECTRICAL CONNECTION:

3 ft cable, ½" conduit fitting	•	•	•	•	•	•	•	•
--------------------------------	---	---	---	---	---	---	---	---

Valve Nominal Size

Ball Valve Model #	C _v Rating	Inches	DN mm	Close-off psi
--------------------	-----------------------	--------	-------	---------------

B2...VSS 2-WAY BALL VALVE WITH NON-SPRING RETURN ACTUATORS

Ball Valve Model #	C _v Rating	Inches	DN mm	Close-off psi	NMB24-3X1	NMX24-MFTX1	AMB24-3X1	AMX24-MFTX1	GMB24-3X1	GMX24-MFTX1	2*GMB24-3X1	2*GMX24-MFTX1
B215VSS	15	½	15	1000	\$658.00	\$968.00						
B219VSS	30	¾	20	1000	\$914.00	\$1,220.00						
B224VSS	43	1	25	1000			\$1,028.00	\$1,292.00				
B232VSS	48	1¼	32	1000			\$1,416.00	\$1,680.00				
B239VSS	84	1½	40	1000					\$1,712.00	\$1,850.00		
B249VSS	108	2	50	400					\$1,998.00	\$2,142.00		
B249VSS	108	2	50	1000							\$2,498.00	\$2,778.00
B265VSS	503	2½	65	200							\$5,742.00	\$6,024.00

MULTI-FUNCTION TECHNOLOGY

Description	P-CODE	Control Input	Running Time	Built-in Feedback	List Price
P-10001	A01	2-10 VDC	150 seconds	2-10 VDC	No Charge
P-10002	A02	0-10 VDC	150 seconds	0-10 VDC	No Charge
P-10028	A28	0-10 VDC	100 seconds	0-10 VDC	No Charge
P-10063	A63	0.5-4.5 VDC	150 seconds	0.5-4.5 VDC	No Charge
P-10064	A64	5.5-10 VDC	150 seconds	5.5-10 VDC	No Charge
P-20002	W02	0.02-5.00 seconds PWM	150 seconds	2-10 VDC	No Charge
P-20003	W03	0.10-25.5 seconds PWM	150 seconds	2-10 VDC	No Charge
P-30001	F01	Floating Point	150 seconds	2-10 VDC	No Charge
P-40002	J02	On/Off	150 seconds	2-10 VDC	No Charge

Add the P... pre-set MFT configuration number and list price to the actuator when ordering, as needed.

Note: Most popular configurations available at no additional cost. All other configurations carry a \$34.00 list price.

Dual mounted actuators use standard run time only (no reprogramming of standard run time allowed).

B2...VSS Series Ball Valve, Spring Return Actuator

2-way Valve, Stainless Steel Body, NPT Female Ends



Valve Specifications

Service	chilled or hot water, 60% glycol, 50# steam
Flow characteristic	modified equal percentage
Action	90° rotation
Sizes	½", ¾", 1", 1¼", 1½", 2"
Type of end fitting	NPT female ends
Materials:	
Body	A351-CF8M stainless steel
Ball	316 stainless steel
Stem	316 stainless steel
Seats	MPTFE
Packing	RPTFE
Gland	B16 brass
Pressure rating	2000 psig WOG (½") 1500 psig WOG (1¼" - 2")
Media temp. range	-22°F to +298°F [-30°C to +148°C]
Maximum velocity	15 FPS



Spring Return Actuators



ACTUATOR PART #	LF24 US	LF24-MFT US	AF24 US	AF24-MFT US	2*AF24 US	2*AF24-MFT US
Control type	On/Off	Proportional/MFT	On/Off	Proportional/MFT	On/Off	Proportional/MFT
Manual override			•	•	•	•
Running time	<40 to 75 seconds spring: <25 seconds	motor: 150 seconds spring: <25 seconds	motor: 150 seconds spring: <20 seconds	motor: <150 seconds spring: <20 seconds	motor: 150 seconds spring: <20 seconds	motor: <150 seconds spring: <20 seconds
Noise level	<50 dB(A) spring: <62 dB(A)	<30 dB(A) spring: <62 dB(A)	<45 dB(A)	<45 dB(A)	<45 dB(A)	<45 dB(A)
ELECTRICAL CONNECTION:						
3 ft cable, ½" conduit fitting	•	•	•	•	•	•
Valve Nominal Size						
Ball Valve	C_v	Inches	DN	Close-off		
Model #	Rating		mm	psi		

B2...VSS 2-WAY BALL VALVE WITH SPRING RETURN ACTUATORS

Ball Valve Model #	C _v Rating	Inches	DN mm	Close-off psi	LF24 US	LF24-MFT US	AF24 US	AF24-MFT US	2*AF24 US	2*AF24-MFT US
B215VSS	15	½	15	1000	\$686.00	\$1,072.00				
B219VSS	30	¾	20	1000			\$1,040.00	\$1,406.00		
B224VSS	43	1	25	1000			\$1,118.00	\$1,498.00		
B232VSS	48	1¼	32	400			\$1,564.00	\$1,996.00		
B232VSS	48	1¼	32	1000					\$2,032.00	\$2,806.00
B239VSS	84	1½	40	1000					\$2,144.00	\$2,948.00
B249VSS	108	2	50	400					\$2,434.00	\$3,178.00

MULTI-FUNCTION TECHNOLOGY

Description	P-CODE	Control Input	Running Time	Built-in Feedback	List Price
P-10001	A01	2-10 VDC	150 seconds	2-10 VDC	No Charge
P-10002	A02	0-10 VDC	150 seconds	0-10 VDC	No Charge
P-10028	A28	0-10 VDC	100 seconds	0-10 VDC	No Charge
P-10063	A63	0.5-4.5 VDC	150 seconds	0.5-4.5 VDC	No Charge
P-10064	A64	5.5-10 VDC	150 seconds	5.5-10 VDC	No Charge
P-20002	W02	0.02-5.00 seconds PWM	150 seconds	2-10 VDC	No Charge
P-20003	W03	0.10-25.5 seconds PWM	150 seconds	2-10 VDC	No Charge
P-30001	F01	Floating Point	150 seconds	2-10 VDC	No Charge
P-40002	J02	On/Off	150 seconds	2-10 VDC	No Charge

Example: AF24-MFT US is the basic model. Add the P... pre-set MFT configuration number and list price to the actuator when ordering, as needed.

Note: Most popular configurations available at no additional cost.

K20945 - 04/09 - Subject to change. © Belimo Aircontrols (USA), Inc.

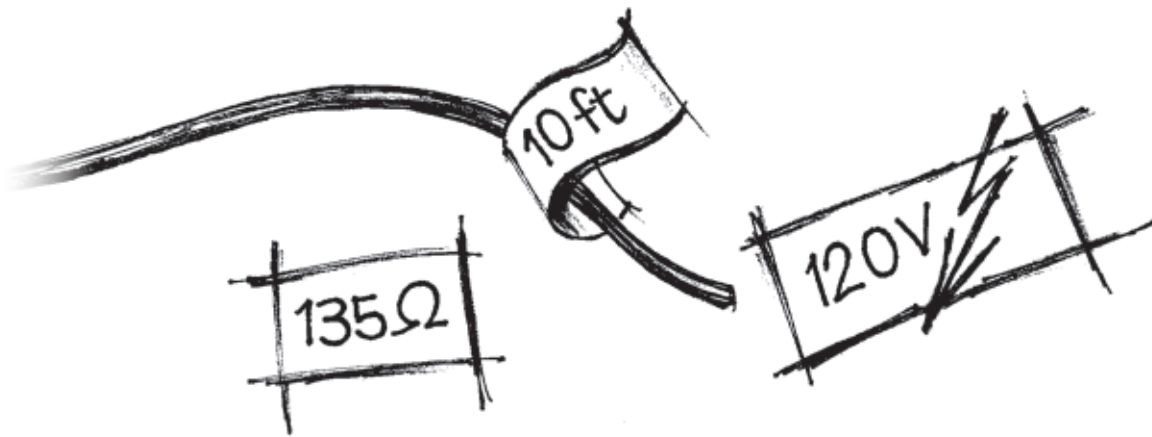

Spring Return Actuator Options



OPTIONS	LF24-S US	LF120 US	LF120-S US	LF24- MFT-S US	AF24-S US	AF120 US	AF120-S US	AF24- MFT-S US	AF24- MFT95 US	2*AF24-S US	2*AF120 US	2*AF120-S US	2*AF24- MFT-S US	2*AF24- MFT95 US
Control type	On/Off	On/Off	On/Off	Proportional/ MFT	On/Off	On/Off	On/Off	On/Off	0-135 Ω	On/Off	Proportional/ MFT	Proportional/ MFT	Proportional/ MFT	0-135 Ω
Built-in auxiliary switch (-S)	•		•	•	•		•	•		•		•	•	
120 VAC power supply		•	•			•	•		•		•	•	•	•
Ball Valve Model #														
C_v Rating														
B2...VSS 2-WAY BALL VALVE WITH SPRING RETURN ACTUATORS														
B215VSS	15	\$742.00	\$720.00	\$776.00	\$1,126.00									
B219VSS	30					\$1,128.00	\$1,094.00	\$1,184.00	\$1,470.00	\$1,405.00				
B224VSS	43					\$1,204.00	\$1,174.00	\$1,258.00	\$1,562.00	\$1,498.00				
B232VSS	48					\$1,654.00	\$1,620.00	\$1,708.00	\$2,084.00	\$2,017.00				
B232VSS	48										\$2,118.00	\$2,142.00	\$2,228.00	\$2,894.00
B239VSS	84										\$2,230.00	\$2,252.00	\$2,340.00	\$3,036.00
B249VSS	108										\$2,520.00	\$2,544.00	\$2,632.00	\$3,264.00

* For tandem actuators – only one of the two actuators is provided with switch. For MFT95 models only one will be MFT95. Note: Specify configuration.

K20945 - 04/09 - Subject to change. © Belimo Aircontrols (USA), Inc.

B2...VSS Series Ball Valve, Non-Spring Return Actuator

2-way Valve, Stainless Steel Body, NPT Female Ends



Valve Specifications

Service	chilled or hot water, 60% glycol, 50# steam
Flow characteristic	modified equal percentage
Action	90° rotation
Sizes	½", ¾", 1", 1¼", 1½", 2", 2 ½", 3"
Type of end fitting	NPT female ends
Materials:	
Body	A351-CF8M stainless steel
Ball	316 stainless steel
Stem	316 stainless steel
Seats	MPTFE
Packing	RPTFE
Gland	B16 brass
Pressure rating	2000 psig WOG (½") 1500 psig WOG (1¼" - 2") 1000 psig WOG (2½"-3")
Media temp. range	-22°F to +298°F [-30°C to +148°C]
Maximum velocity	15 FPS



Non-Spring Return Actuators

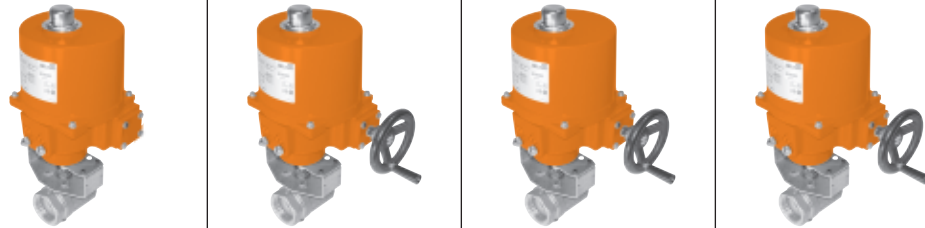

ACTUATOR PART #	SY1-24 SY1-110 SY1-220	SY1-24P SY1-110P SY1-220P	SY2-24 SY2-110 SY2-220	SY3-24 SY3-110 SY3-220				
Control type	On/Off, Floating Point	Proportional	On/Off, Floating Point	On/Off, Floating Point				
Manual override	•	•	•	•				
Running time	12 seconds	12 seconds	15 seconds	22 seconds				
ELECTRICAL CONNECTION:								
2 (two), ½" conduit fittings / covered terminal strip	•	•	•	•				
Valve Nominal Size								
Ball Valve Model #	C_v Rating	Inches	DN mm	Close-off psi				
B2...VSS 2-WAY BALL VALVE WITH NON-SPRING RETURN ACTUATORS								
B215VSS	15	½	15	1000	\$1,384.00	\$3,290.00	\$2,582.00	
B219VSS	30	¾	20	1000	\$1,582.00	\$3,488.00	\$2,766.00	
B224VSS	43	1	25	1000	\$1,660.00	\$3,566.00	\$2,842.00	
B232VSS	48	1¼	32	1000	\$2,042.00	\$3,948.00	\$3,312.00	
B239VSS	84	1½	40	1000	\$2,154.00	\$4,062.00	\$3,426.00	
B249VSS	108	2	50	1000			\$3,724.00	
B265VSS	503	2½	65	1000				\$7,264.00
B280VSS	370	3	80	600				\$7,796.00

Note: Specify configuration.

K20945 - 04/09 - Subject to change. © Belimo Aircontrols (USA), Inc.

Valve Specifications

Service	chilled or hot water, 60% glycol, 50# steam
Flow characteristic	modified equal percentage
Action	90° rotation
Sizes	½", ¾", 1", 1¼", 1½", 2", 2 ½", 3"
Type of end fitting	NPT female ends
Materials:	
Body	A351-CF8M stainless steel
Ball	316 stainless steel
Stem	316 stainless steel
Seats	MPTFE
Packing	RPTFE
Gland	B16 brass
Pressure rating	2000 psig WOG (½") 1500 psig WOG (1¼" - 2") 1000 psig WOG (2½"-3")
Media temp. range	-22°F to +298°F [-30°C to +148°C]
Maximum velocity	15 FPS



Non-Spring Return Actuators



ACTUATOR PART #	SY2-24MFT SY2-120MFT SY2-230MFT	SY3-24MFT SY3-120MFT SY3-230MFT				
Control type	Proportional/MFT	Proportional/MFT				
Manual override	•	•				
Running time	15 seconds	22 seconds				
ELECTRICAL CONNECTION:						
2 (two), ½" conduit fittings / covered terminal strip	•	•				
Valve Nominal Size						
Ball Valve Model #	C_v Rating	Inches	DN mm	Close-off psi		
B2...VSS 2-WAY BALL VALVE WITH NON-SPRING RETURN ACTUATORS						
B215VSS	15	½	15	1000	\$4,666.00	
B219VSS	30	¾	20	1000	\$4,846.00	
B224VSS	43	1	25	1000	\$4,924.00	
B232VSS	48	1¼	32	1000	\$5,396.00	
B239VSS	84	1½	40	1000	\$5,510.00	
B249VSS	108	2	50	1000	\$5,804.00	
B265VSS	503	2½	65	1000		\$9,298.00
B280VSS	370	3	80	600		\$9,828.00

Note: Specify configuration.

B6...VS Series Ball Valve, Non-Spring Return Actuator

2-way Valve, Cast Iron Flanged Body with NEMA 4X Industrial Style Actuator



Valve Specifications

Service	chilled or hot water, 60% glycol, 50# steam
Flow characteristic	modified equal percentage
Action	90° rotation
Sizes	2", 2½", 3", 4", 6", 8", 10"
Type of end fitting	flanged 125# ANSI bolt pattern
Materials:	
Body	cast iron - ASTM A126 class B
Ball	304 stainless steel - ASTM A351
Stem	304 stainless steel - AISI 304
Seats	MPTFE
Packing	PTFE
Gland	cast iron - ASTM A126 class B
Gasket	PTFE
Lever Nut	steel - ASTM A6
Pressure rating	200 psi WOG
Media temp. range	-22°F to +280°F [-30°C to +138°C]
Maximum differential pressure (ΔP)	<200 psi



Non-Spring Return Actuators



ACTUATOR PART #	SY2-24 SY2-110 SY2-220	SY3-24 SY3-110 SY3-220	SY4-24 SY4-110 SY4-220	SY5-24 SY5-110 SY5-220	SY8-24 SY8-110 SY8-220
Control type	On/Off, Floating Point	On/Off, Floating Point	On/Off, Floating Point	On/Off, Floating Point	On/Off, Floating Point
Manual override	•	•	•	•	•
Running time	15 seconds	22 seconds	16 seconds	22 seconds	46 seconds
ELECTRICAL CONNECTION:					
2 (two), ½" conduit fittings / covered terminal strip	•	•	•	•	•
Valve Nominal Size					
Ball Valve Model #	C_v Rating	Inches	DN mm	Close-off psi	
B6...VS 2-WAY BALL VALVE WITH NON-SPRING RETURN ACTUATORS					
B650VS	330	2	50	200	\$3,928.00
B665VS	420	2½	65	200	\$4,064.00
B680VS	600	3	80	200	\$4,198.00
B6100VS	1200	4	100	200	\$5,342.00
B6150VS	3300	6	150	200	\$10,772.00
B6200VS	9000	8	203	200	\$14,412.00
B6250VS	12400	10	254	200	\$34,436.00

Note: Specify configuration.

K20945 - 04/09 - Subject to change. © Belimo Aircontrols (USA), Inc.

Valve Specifications

Service	chilled or hot water, 60% glycol, 50# steam
Flow characteristic	modified equal percentage
Action	90° rotation
Sizes	2", 2½", 3", 4", 6", 8", 10"
Type of end fitting	flanged 125# ANSI bolt pattern
Materials:	
Body	cast iron - ASTM A126 class B
Ball	304 stainless steel - ASTM A351
Stem	304 stainless steel - AISI 304
Seats	MPTFE
Packing	PTFE
Gland	cast iron - ASTM A126 class B
Gasket	PTFE
Lever Nut	steel - ASTM A6
Pressure rating	200 psi WOG
Media temp. range	-22°F to +250°F [-30°C to +120°C]
Maximum differential pressure (ΔP)	<200 psi



Non-Spring Return Actuators

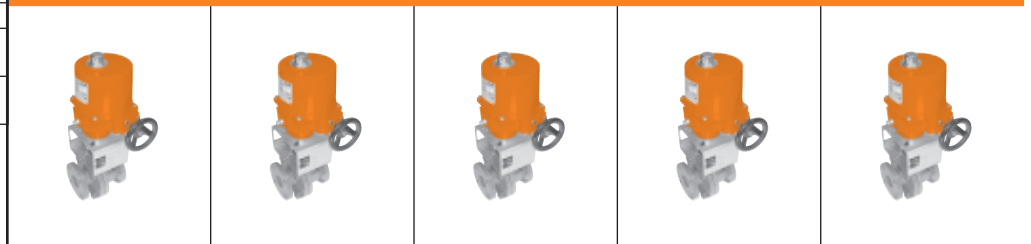

ACTUATOR PART #	SY2-24MFT SY2-120MFT SY2-230MFT	SY3-24MFT SY3-120MFT SY3-230MFT	SY4-24MFT SY4-110MFT SY4-220MFT	SY5-24MFT SY5-110MFT SY5-220MFT	SY8-110MFT SY8-220MFT
Control type	Proportional/MFT	Proportional/MFT	Proportional/MFT	Proportional/MFT	Proportional/MFT
Manual override	•	•	•	•	•
Running time	15 seconds	22 seconds	16 seconds	22 seconds	46 seconds
ELECTRICAL CONNECTION:					
2 (two), ½" conduit fittings / covered terminal strip	•	•	•	•	•
Valve Nominal Size					
Ball Valve Model #	C_v Rating	Inches	DN mm	Close-off psi	

B6...VS 2-WAY BALL VALVE WITH NON-SPRING RETURN ACTUATORS					
B650VS	330	2	50	200	\$5,936.00
B665VS	420	2½	65	200	\$6,144.00
B680VS	600	3	80	200	\$6,234.00
B6100VS	1200	4	100	200	\$7,870.00
B6150VS	3300	6	150	200	\$12,812.00
B6200VS	9000	8	203	200	\$15,808.00
B6250VS	12400	10	254	200	\$35,282.00

Note: Specify configuration.

Valve Accessories

Ball Valves



WEATHERSHIELDS		Non-Spring Return				Spring Return			List Price
		LM	NM	AM	GM	LF	NF	AF	
	ZS-SPBV-30 LM/NM/LF series on VS/VSS	•	•			•			\$234.00
	ZS-SPBV-10 AM/GM/NF/AF series on VS/VSS			•	•		•	•	\$234.00
	ZS-SPBV-20 Dual GM/AF series on VS/VSS				•			•	\$418.00
AUXILIARY SWITCHES & POTENTIOMETERS									
	S1A Auxiliary switch - 1x SPDT, 3A (0.5A Inductive) @ 250 VAC		•	•	•	•			\$74.00
	S2A Auxiliary switch - 1x SPDT, 3A (0.5A Inductive) @ 250 VAC		•	•	•	•			\$116.00
	P140A Feedback potentiometer 140 Ω		•	•	•	•			\$116.00
	P500A Feedback potentiometer 500 Ω		•	•	•	•			\$116.00
	P1000A Feedback potentiometer 1000 Ω		•	•	•	•			\$116.00
	P2800A Feedback potentiometer 2800 Ω		•	•	•	•			\$116.00
	P5000A Feedback potentiometer 5000 Ω		•	•	•	•			\$116.00
	P10000A Feedback potentiometer 10000 Ω		•	•	•	•			\$116.00
BATTERY BACKUP									
	NSV24 US Battery backup module		•	•	•	•			\$492.00
	NSV-BAT US 12VDC 1.2 AH battery (2 required)		•	•	•	•			\$106.00

Note: Each NSV-24 US requires 2 NSV-BAT.

K20945 - 04/09 - Subject to change. © Belimo Aircontrols (USA), Inc.